



Tips on How to Coach a Virtual FTC Team

By Patti Poston
FIRST Senior Mentor

FIRST
TECH
CHALLENGE



PRESENTED BY
Qualcomm

FOR INSPIRATION & RECOGNITION OF SCIENCE & TECHNOLOGY

Virtual Platforms

Virtual Platforms

- Zoom
- Slack
- Discord
- Google Meets
- Free Teleconference.com
- Ring Central







Team Management Resources



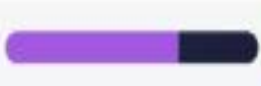

- Trello.com
- Monday.com
- Google Drive
- Microsoft OneNote
- Asana.com
- Jira – Atlassian.com
- Microsoft Planner

Team projects

This month

	Owner	Timeline	Status	Due date	
Finalize kickoff materials			Done	Oct 12	+
Approve budget			Working on it	Oct 5	
A/B test launch			Stuck	Oct 1	

Last month

	Owner	Timeline	Status	Due date	
Get offers from vendors			Done	Sep 22	+
Timeline approval			Done	Sep 22	
Review workload reports			Done	Sep 22	

How to Engage/Motivate

- Fun Fridays
 - Codenames
 - Scattegories
 - Jackbox.tv
 - Scribblo.io
 - Kahoot
- Show and Tell with team
- Watch Parties
 - FIRSTNevada YouTube Channel
 - The Orange Alliance
- Team leaders run meetings
- XRCSimulator -

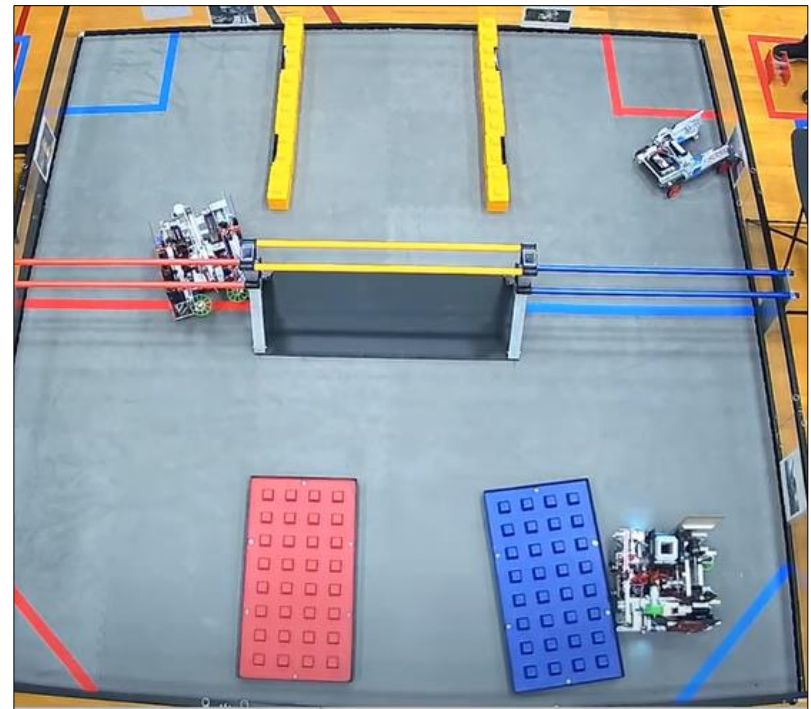

Outreach

Virtually

- Volunteer for community
- Connect with teams
- Mentor teams
- Host webinars
- Presentations
 - Companies
 - Nonprofits



Robot Game - Design

- Design systems in CAD
 - FreeCad
 - OnShape
 - Fusion 360
 - Google Sketchup
 - Solidworks
 - GrabCAD

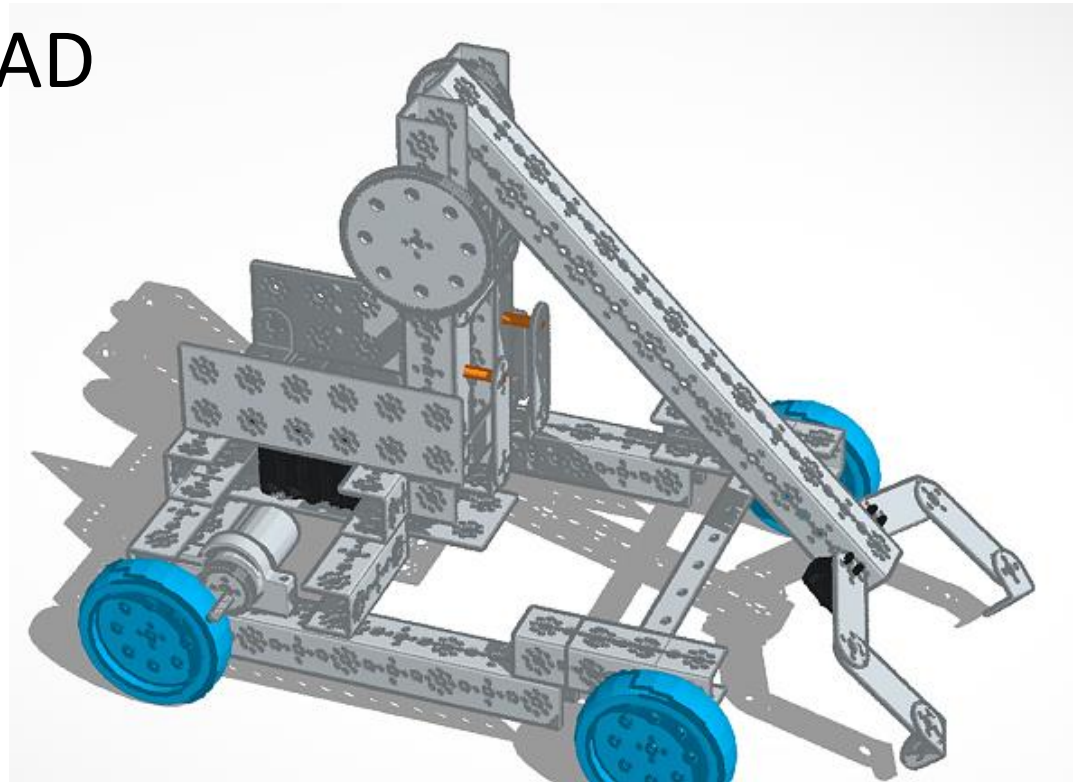

Robot Game - Building

- Getting Started in [FTC Link](#)
- Virtual Kickoff
- Rotate equipment
 - Notes in Engineering Notebook
- Subsystems
- Small groups
- Virtual building meetings
- Do simple robot this year

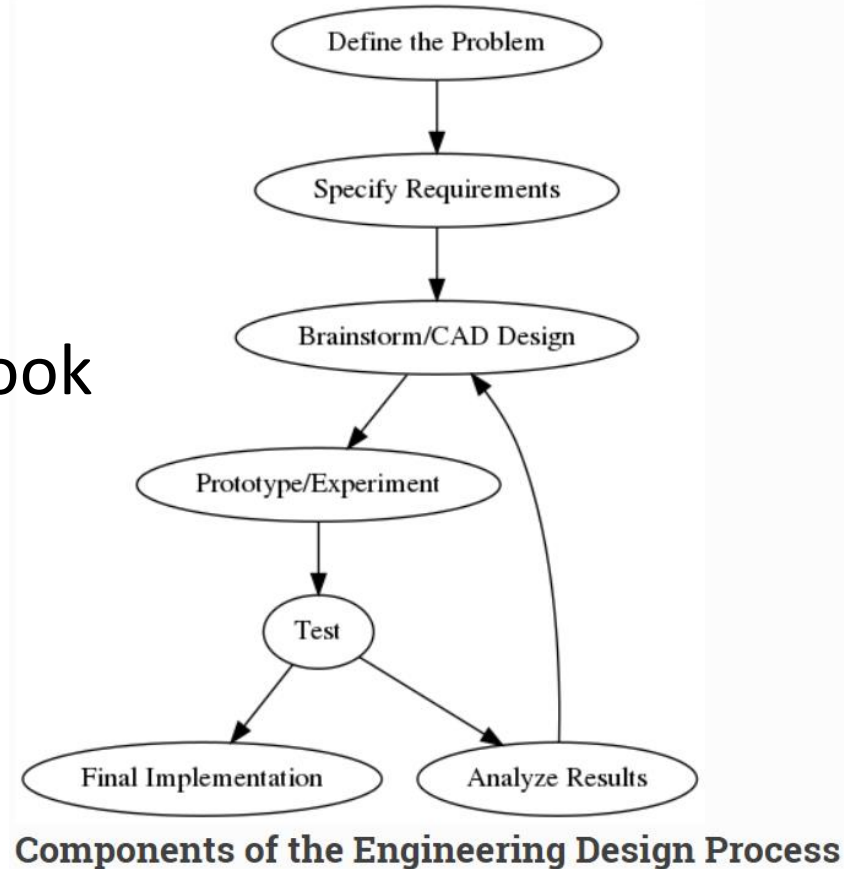

Programming - learning

- STEM Robotics 102
- SoloLearn
- FRC/FTC Teams
- FTC Reddit
- FTC Workshops
- Online Blocks Programming Help
- FTC Github – debugging/developing

Unit 1: Introduction to Programming

Unit 2: Introduction to Java

Unit: Introduction to Programming Robots

Unit 4: Basic Java

Unit 5: Flow Control

Unit 6: Methods

Unit 7: Objects

Unit 8: Advanced Objects

Programming - Sharing

- Robot at one house with field – tester
- GitHub
- FTC Team [Beta 8397 Simulator](#)

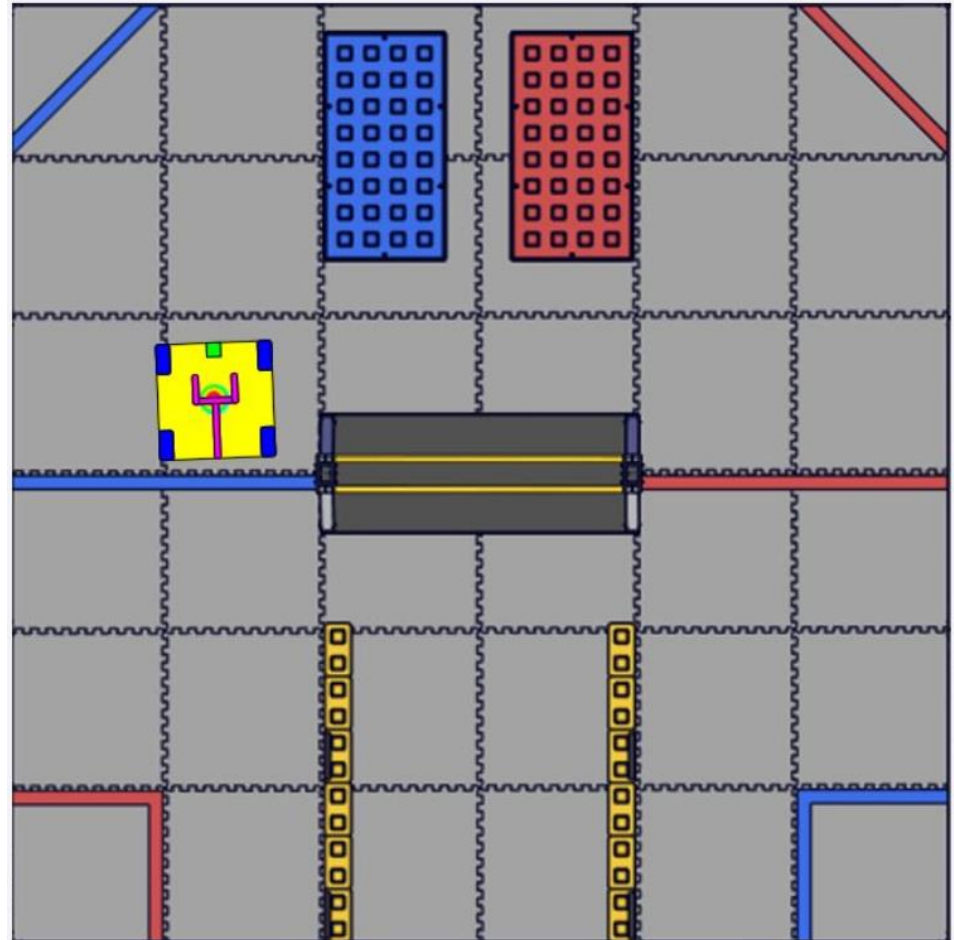

Practice Driving

- Have 1 driver this year?
- Virtual Driver 2 and coach
- Play Rocket League or other games
- Virtual Strategy session
- Build simple robot
- [XRCSimulator](#)
- Rotate robot

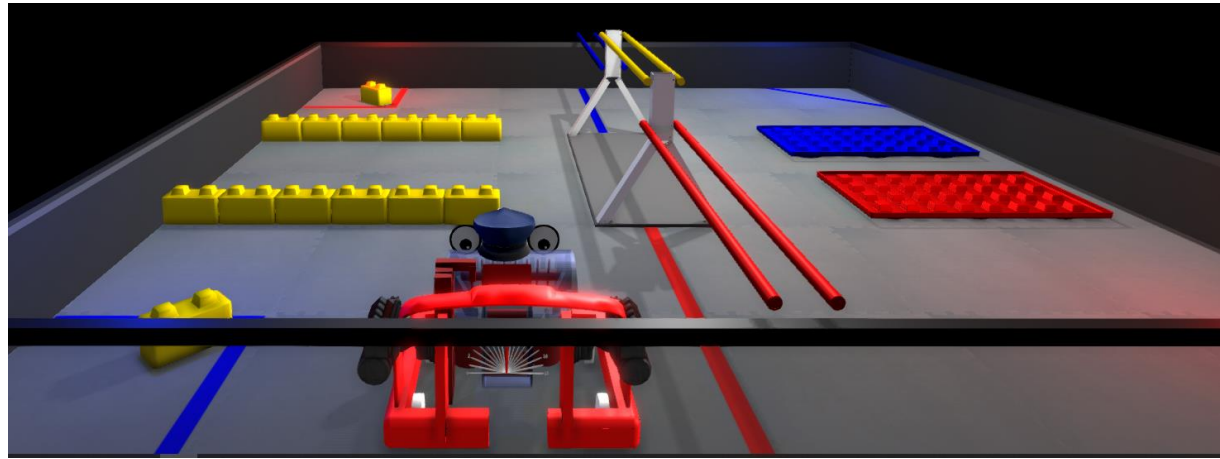



Questions?



PRESENTED BY
Qualcomm